

HP® P1006

CARTRIDGE REMANUFACTURING INSTRUCTIONS



HP® P1006 LASER PRINTER



HP® P1006 TONER CARTRIDGE

REMANUFACTURING THE HP LASERJET P1006 SERIES TONER CARTRIDGE CB435A

By Mike Josiah

In November 2007, Hewlett Packard released the LaserJet P1006 printer. The HP P1006 series of laser printers are based on a 17 ppm, true 600dpi Canon engine. These cartridges use a chip that controls the toner low functions. The CB435A is rated for 1,500 pages. Physically, the cartridges look like a small 12A (1012) cartridge, but there are many differences.

The printer itself has a very small foot print. It's a nice small office/home machine. The first page out is stated to be in under 8.5 seconds from a power save mode. The memory is fixed and not expandable at 8Mb. The recommended monthly volume is from 250-1500 pages/month, but the maximum monthly duty cycle is 5,000 pages. Unlike many small printers these machines have an input tray that can hold 150 pages. A nice touch!

The system that holds the two halves of the cartridge together is completely new. The good news here is that you don't have to cut holes in the cartridge to get access to the pins!

The toner inside is also new. HP is stating that the toner now has "spherically shaped particles". We are currently investigating if this means the toner is chemical or conventional toner that has been thermally rounded. My guess is that it is thermally rounded toner, but until our investigations are finished, we won't know for sure.



In addition to the new toner, the chips have also had "intelligence added" to help aid cartridge ordering when supplies are low. Again, we are investigating the chips for these cartridges as I write this. I can say I have run the same cartridge now 5 times, and the chip has not shut the printer down. Just the toner low features are not working. The printer when new comes with a starter cartridge that is rated for 700 pages at 5% coverage, so your customers will be coming to you fairly quickly! The starter cartridges and replacement 35A (1500 page) cartridges are physically the same so you can make a "High Yield" cartridge from the starter. (If you can call 1500 pages high yield!)

So far there are four printers based on this engine. The P1000, the P1006, the P1007 and the P1008. At the time of this writing, only the P1006 has been released. The other models are referred to in the service manual.

Cartridge troubleshooting as well as running test pages, cleaning pages and some simple printer troubleshooting will be covered at the end of this article.

SUPPLIES REQUIRED

1. 100g (Preliminary weight) HP-P1006 toner (Unique to this series)
2. New Drum (Unique to this series)
3. Wiper Blade (Unique to this series)
4. Dr. Blade (Unique to this series)
5. Magnetic roller (Unique to this series)
6. Sealing Strip (Unique to this series)
7. Cotton Swabs
8. Isopropyl Alcohol
9. Drum Padding Powder
10. Conductive Grease

TOOLS REQUIRED

1. Phillips head screw driver
2. Small Common screw driver
3. Needle nose pliers
4. Jewelers Screwdriver set

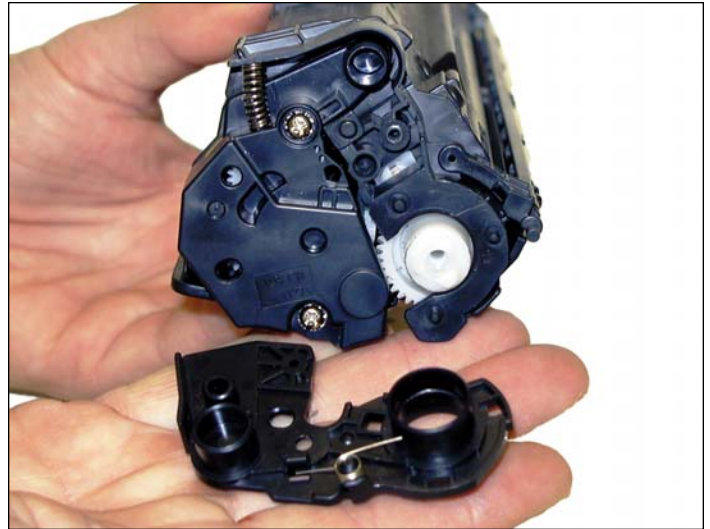
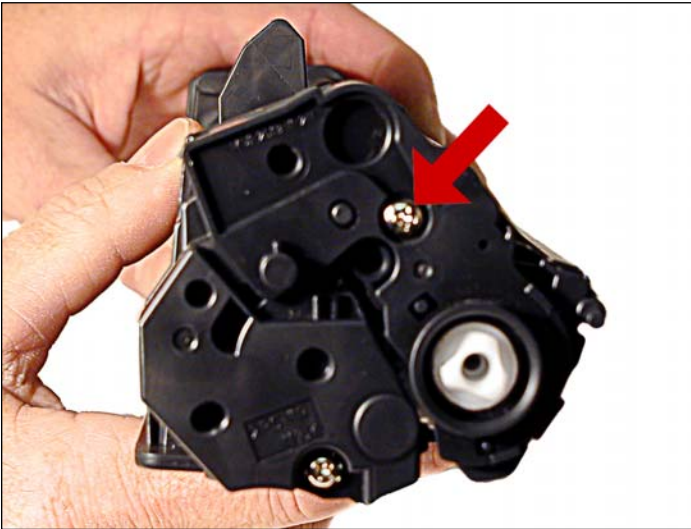

1. With the handle facing you, Remove the Right side screw and end cap from the cartridge. Be careful of the drum cover spring! Remove it with the end cap.

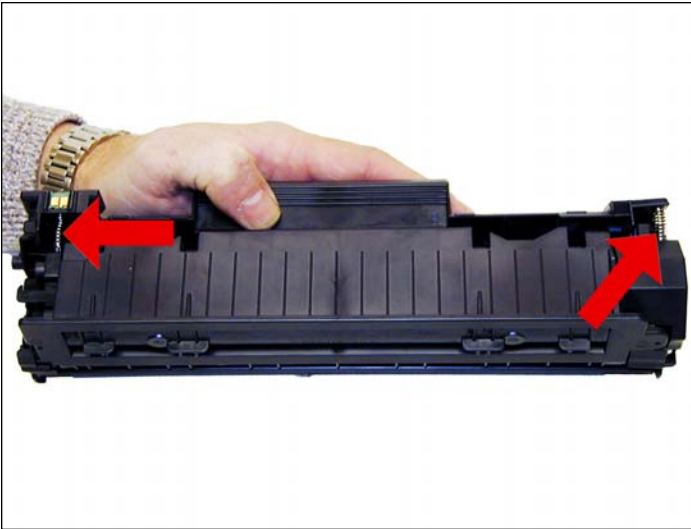

2. With the pair of needle nose pliers, release both the hopper tension springs.

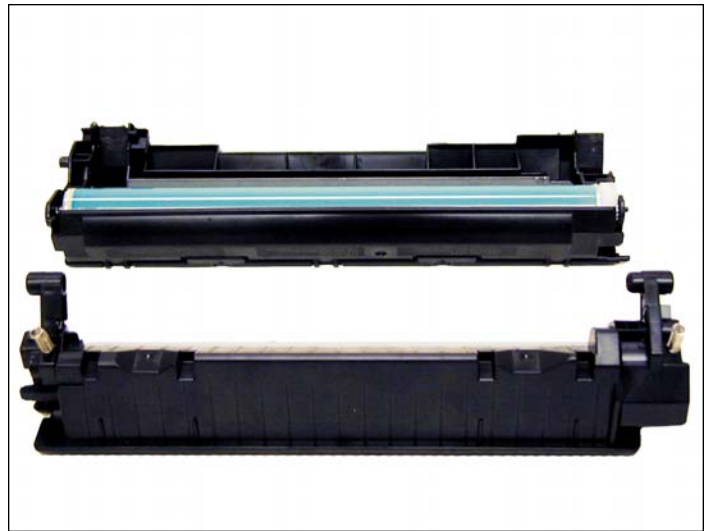
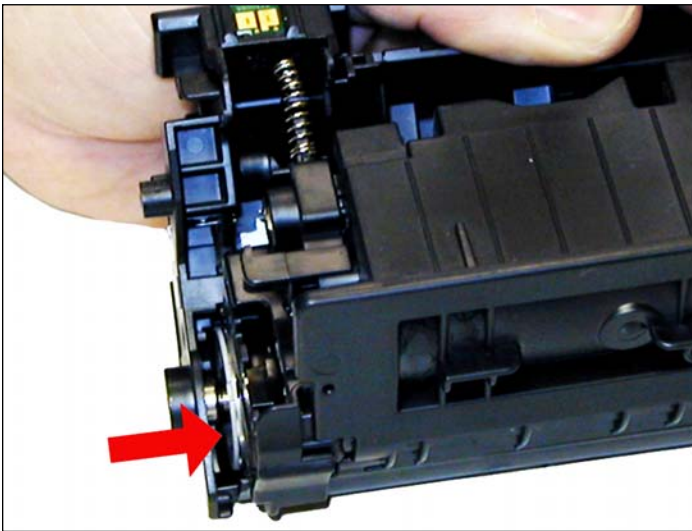

3. Slide the waste/drum section over to the left side. Separate the two halves.



4. On the waste/drum section, lift the drum up from the gear side. Twist and remove from the hopper.

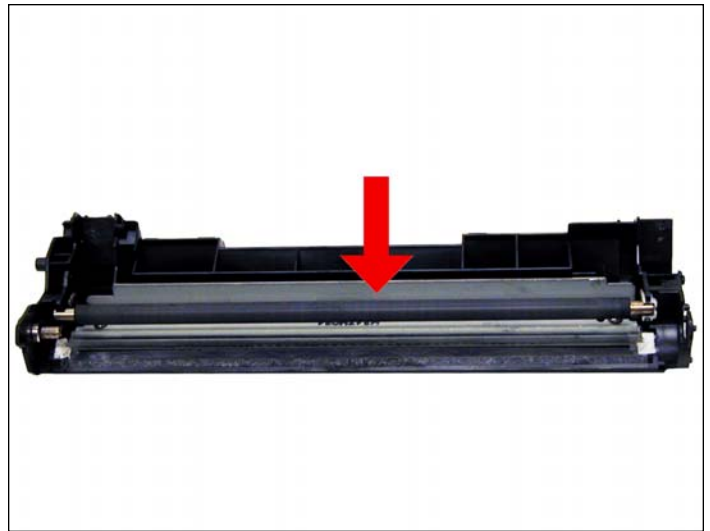

5. Remove the PCR and clean with your standard PCR cleaner.

NOTES

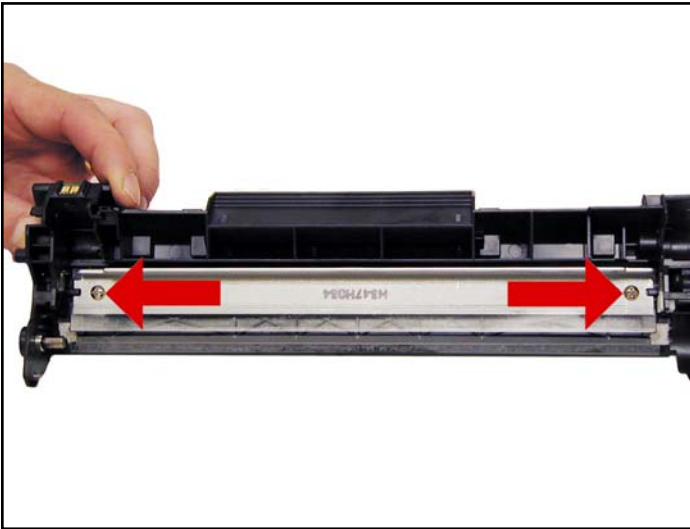

6. Remove the two screws and the wiper blade.

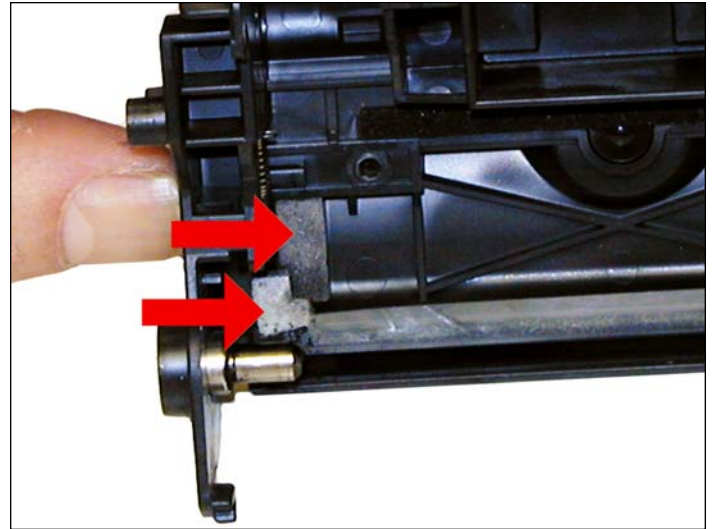
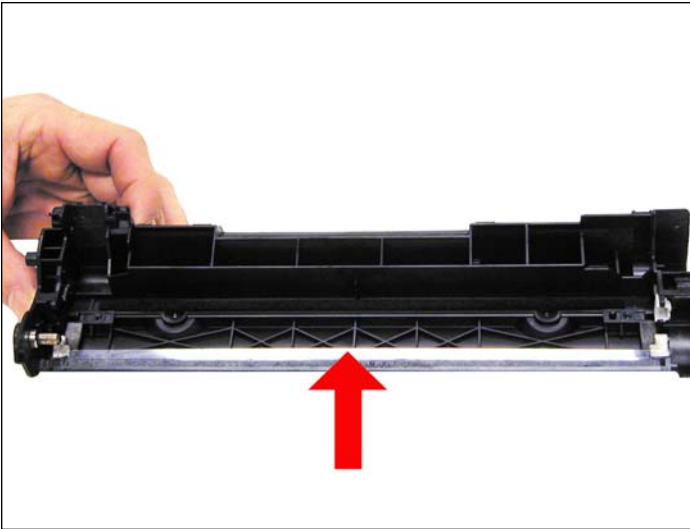

7. Clean out all the waste toner from the hopper. Be careful not to damage the recovery blade located next to the wiper blade. If this blade is bent in any way, the cartridge will leak. Make sure the wiper blade foam seals are clean.



8. Coat the new/cleaned wiper blade with your preferred lubricant. Install the wiper blade and 2 screws.

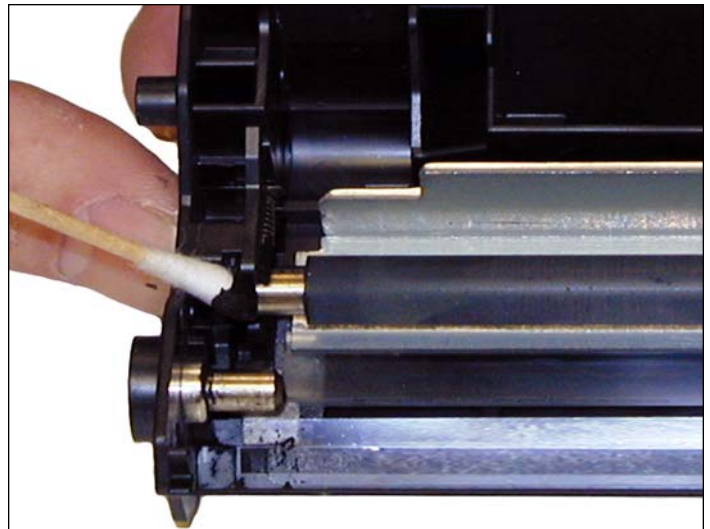

9. Install the cleaned PCR. Place a small amount of conductive grease on to the black holder side of the shaft. Just a small amount of grease is more than sufficient.

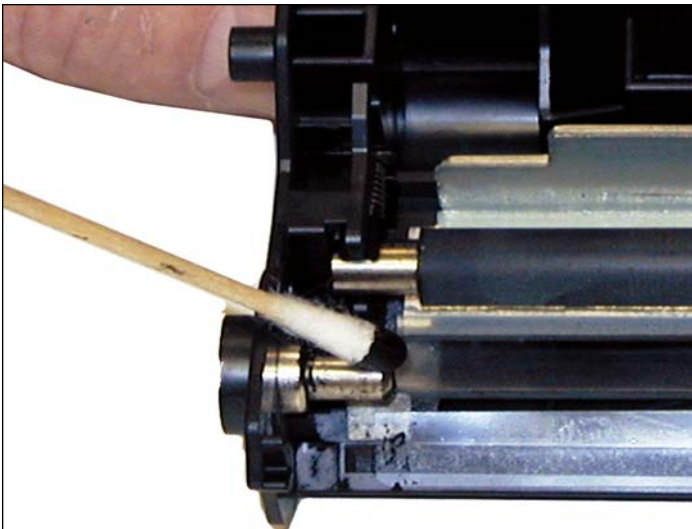

10. Place another small amount of conductive grease on to the metal drum axle.



11. Install the new/cleaned drum hub side first.

12. Place the waste/drum section aside.

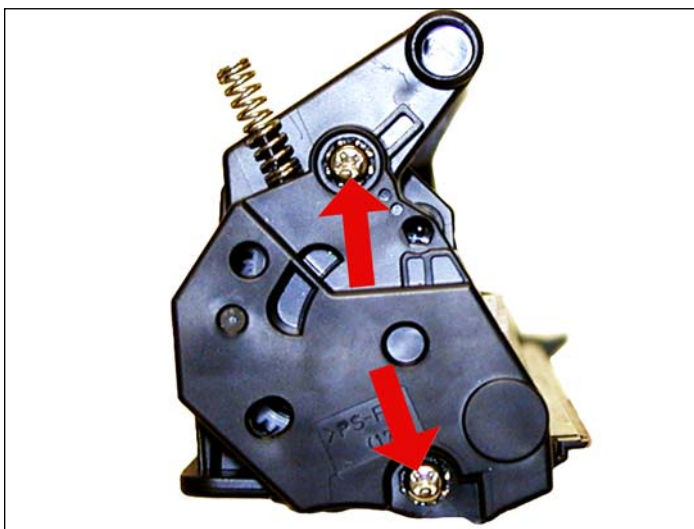

13. On the toner supply chamber right side, Remove the two screws and end cap. Note that these screws have lock washers.

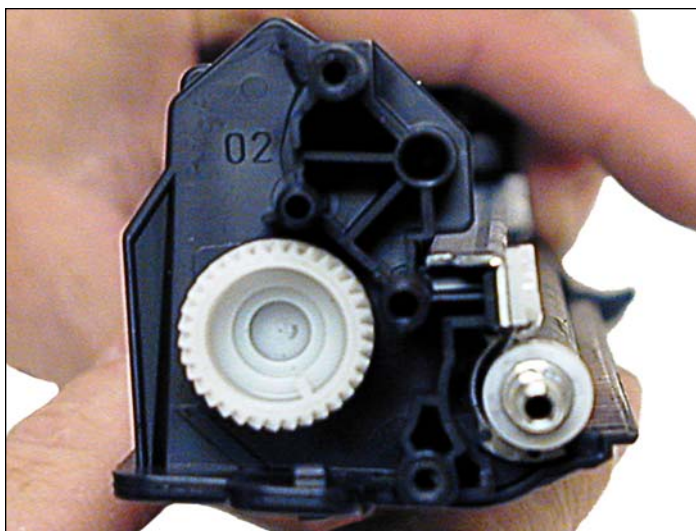
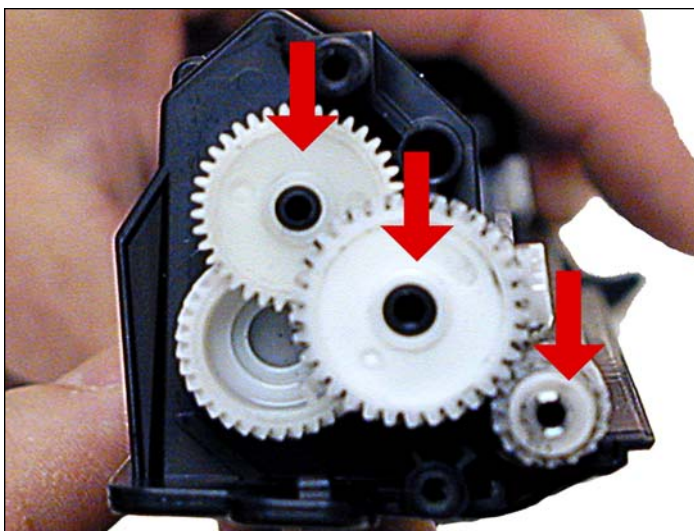

14. Remove the gears from the hopper as shown. Leave the large auger gear in place.

NOTES

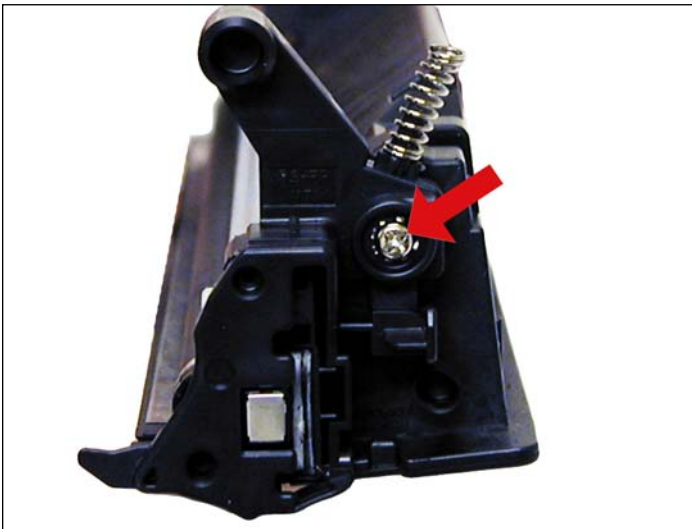

15. Remove the single screw and end from the opposite side.

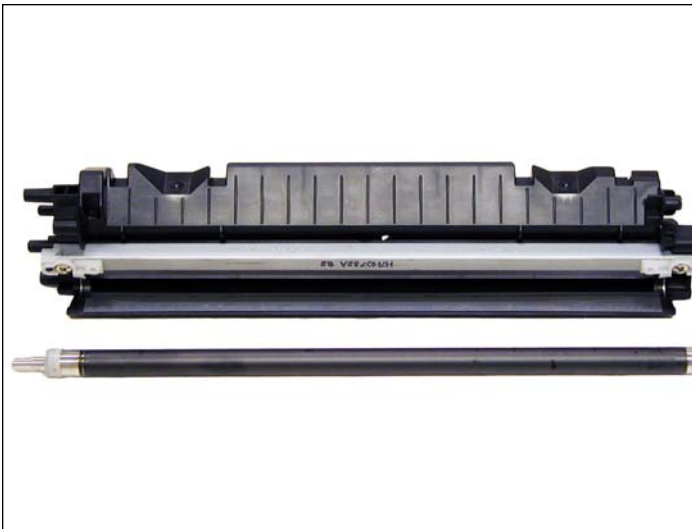

16. Remove the magnetic roller assembly. Be careful of the bushings! They are very fragile.



17. Remove the doctor blade and two screws.

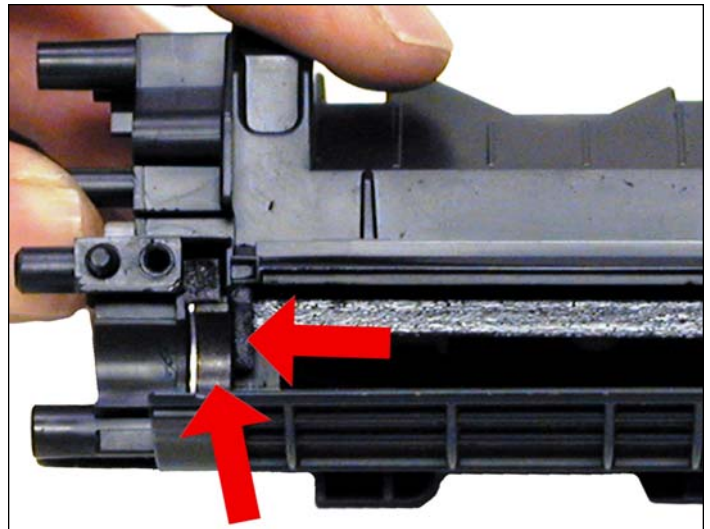

18. Clean out all the remaining toner from the hopper. Make sure the magnetic roller seals and the doctor blade seals are all clean.



19. Fill the hopper with 100g P1006 toner.

NOTES

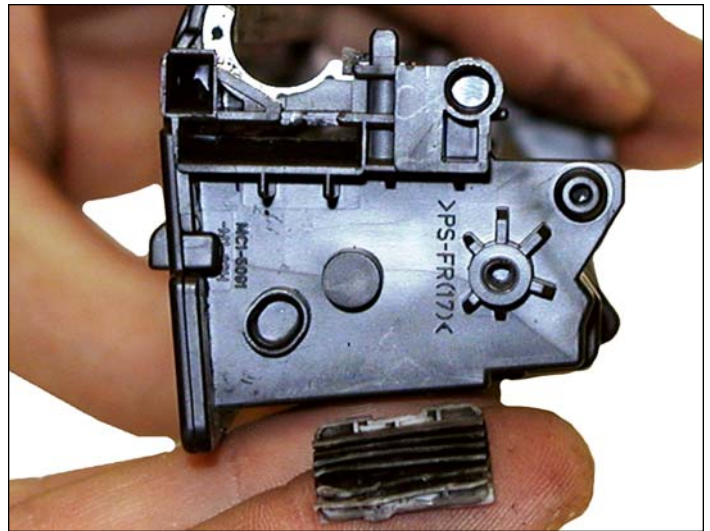
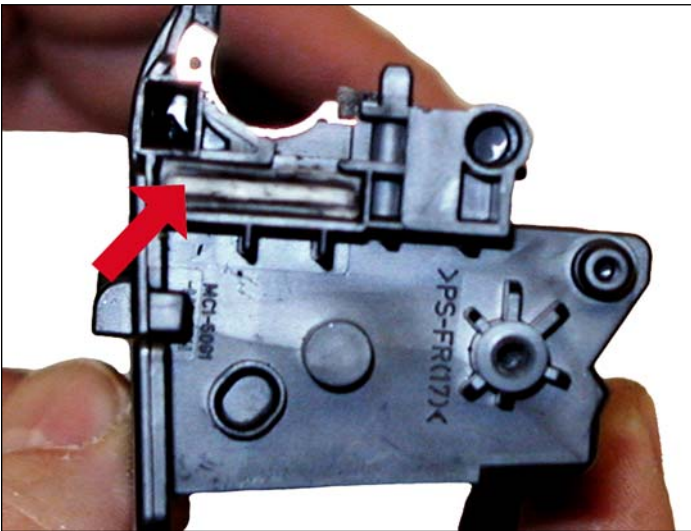

20. When a seal becomes available, remove the seal port plug, and install the seal. Bring the tail out through the seal port hole. Install the plug.

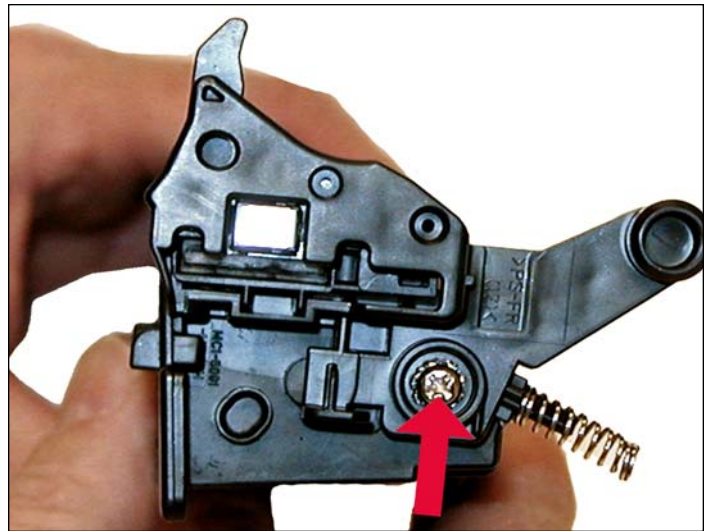
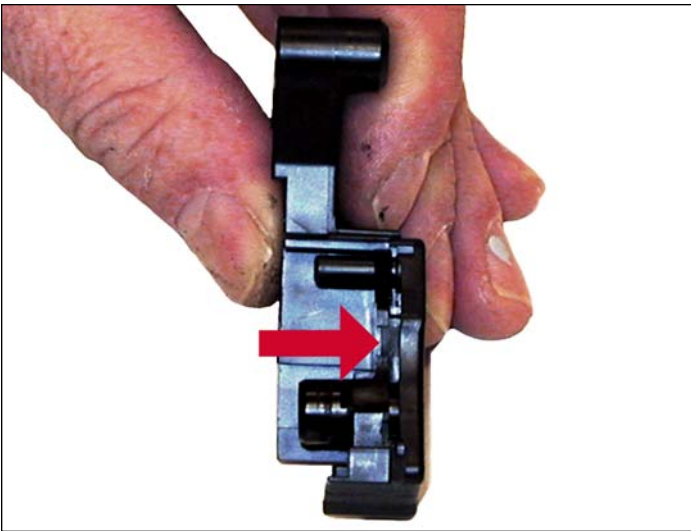

21. Install the left side end cap and screw. Make sure the small contact piece is installed correctly on the end cap.

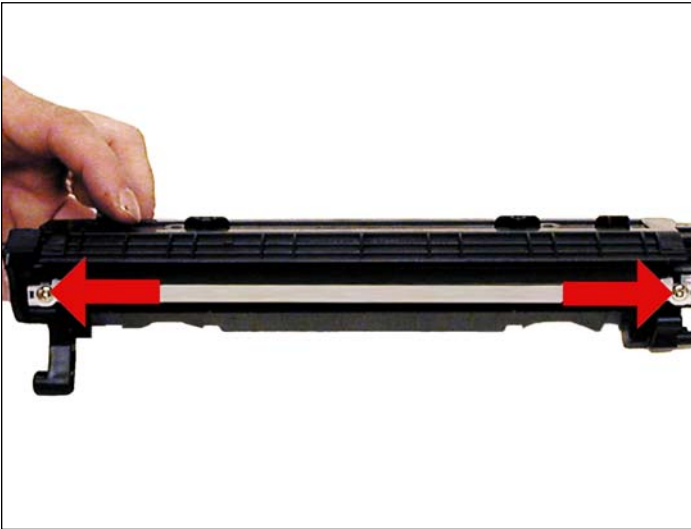

22. Install the doctor blade and two screws.

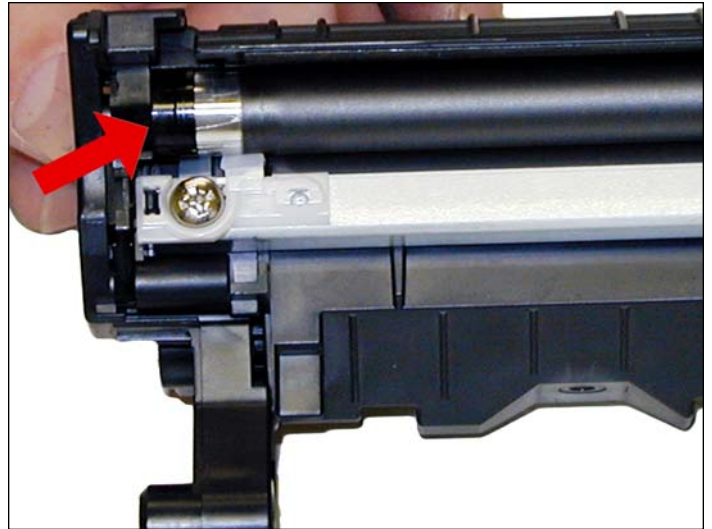

23. Install the magnetic roller black bushing side first. Turn the roller until the keyed end locks in place.

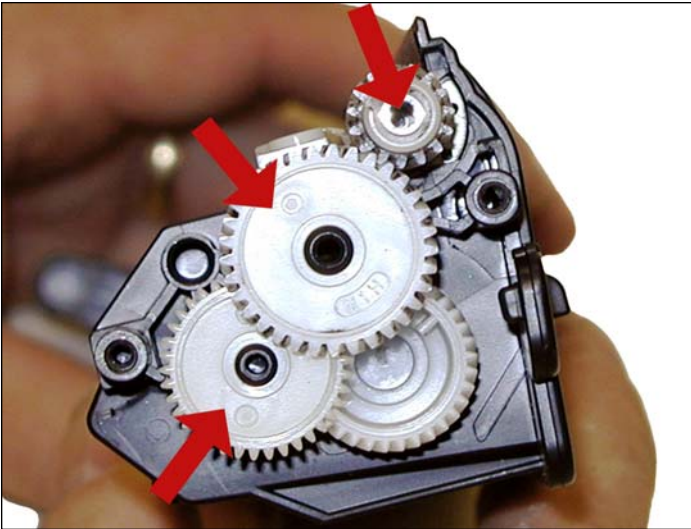

24. Install the gears as shown.

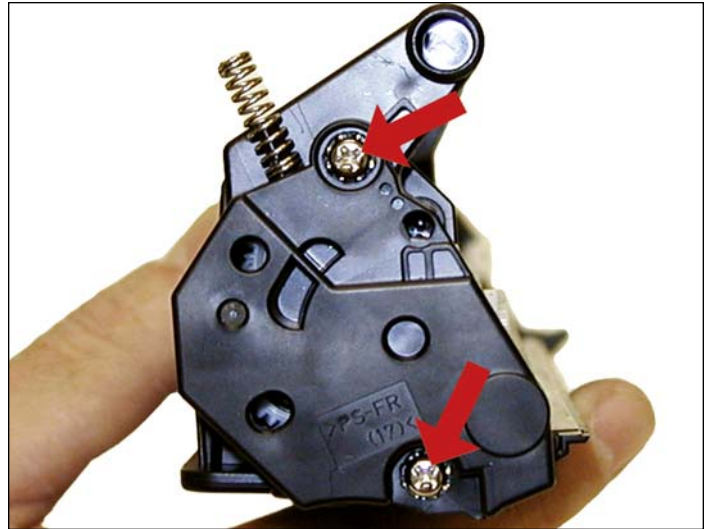

25. Install the end cap and screws.

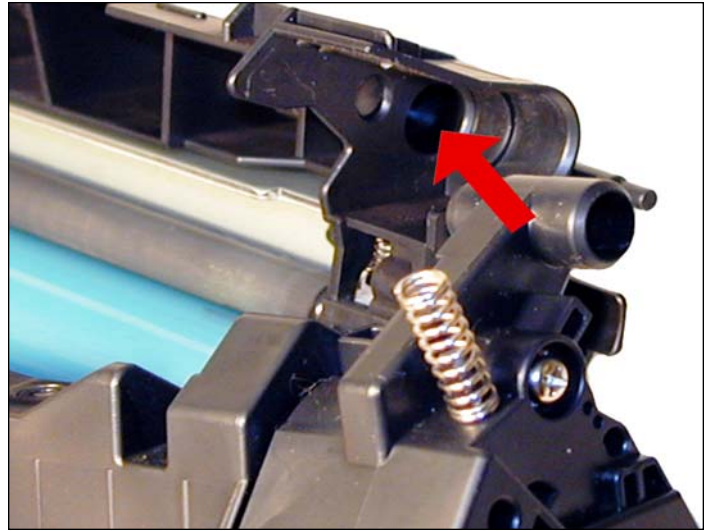
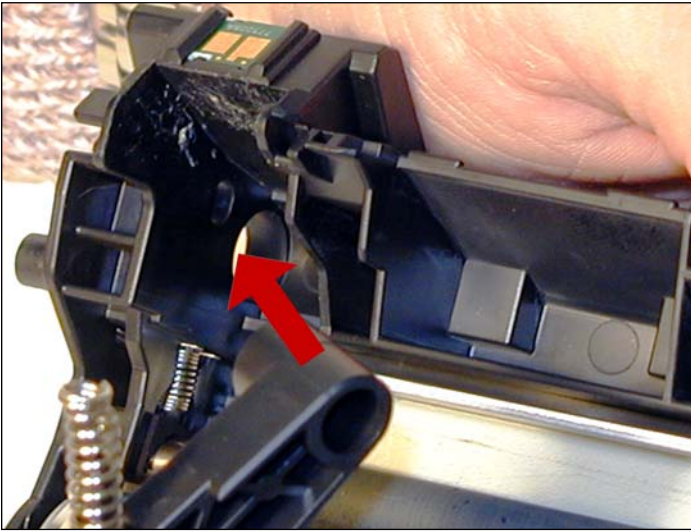

26. Place the drum/waste hopper into the toner hopper. Slide it over so the round hinge pins fit into their respective holes.

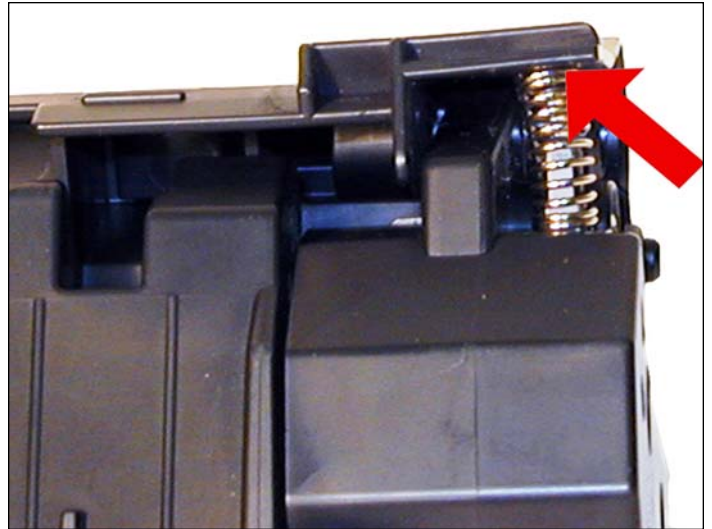
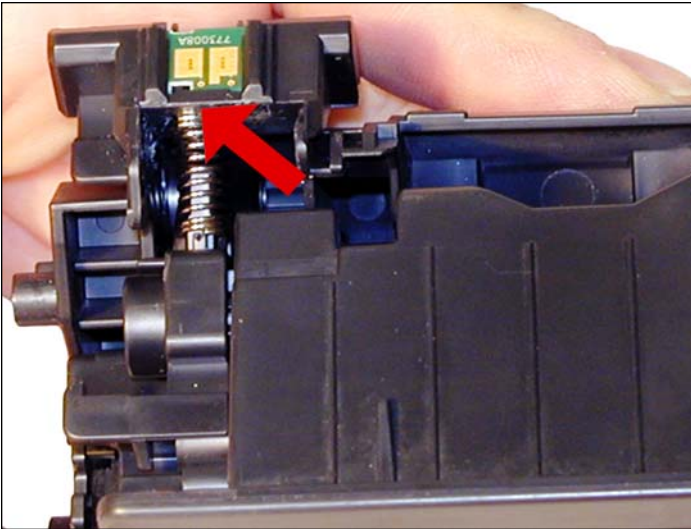

27. Set the hopper tension springs back in place.

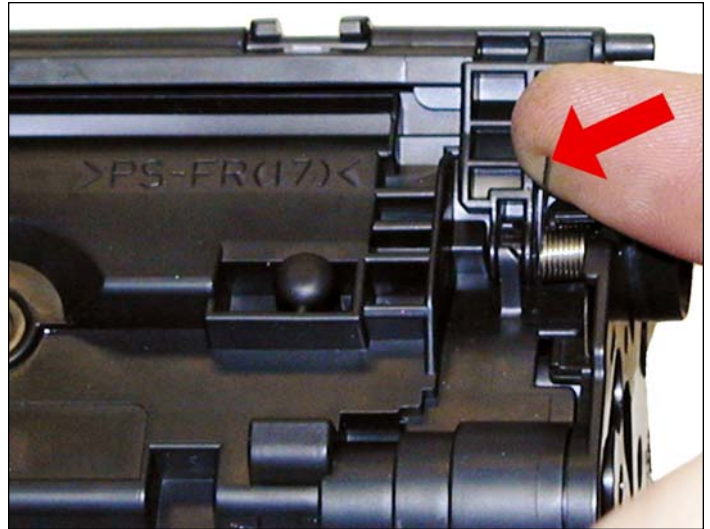
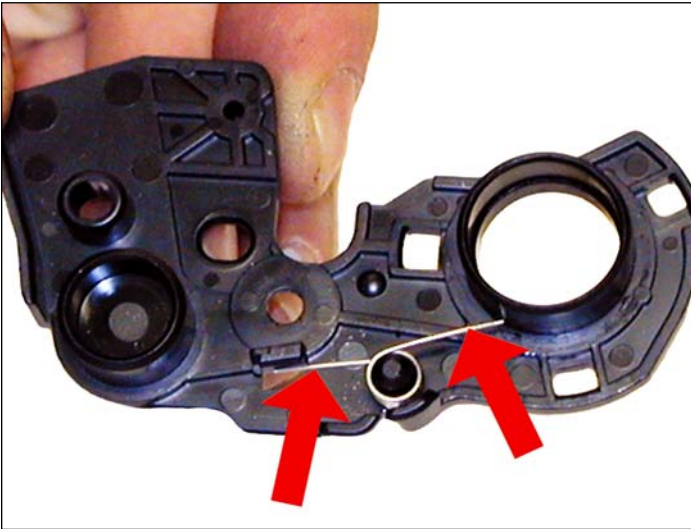

28. With the drum cover spring as shown on the end cap, install the end cap. Lift up the tail of the spring to fit onto the hopper.

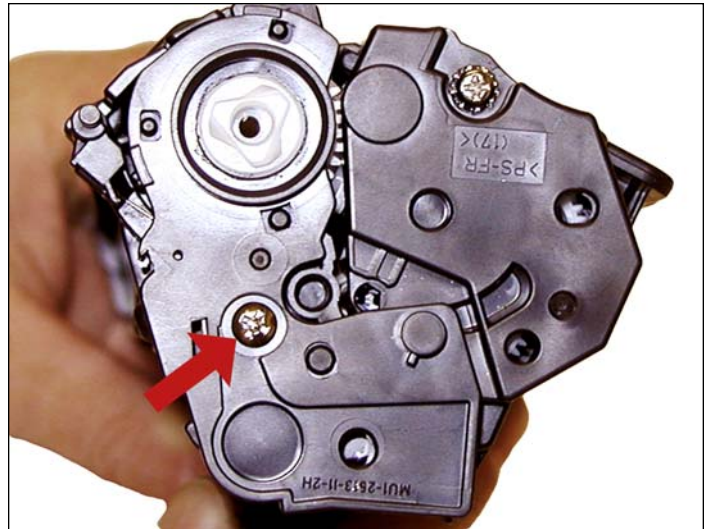
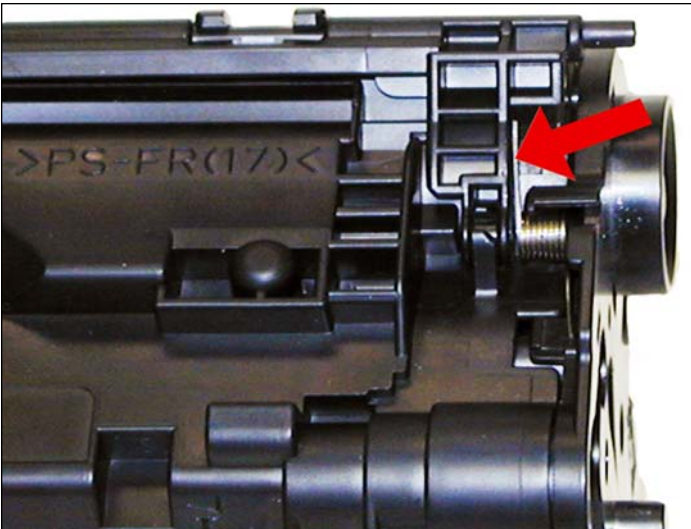

29. Lift up the drum cover sprint tail to fit as shown on the drum cover. Install the screw into the cover.

NOTES

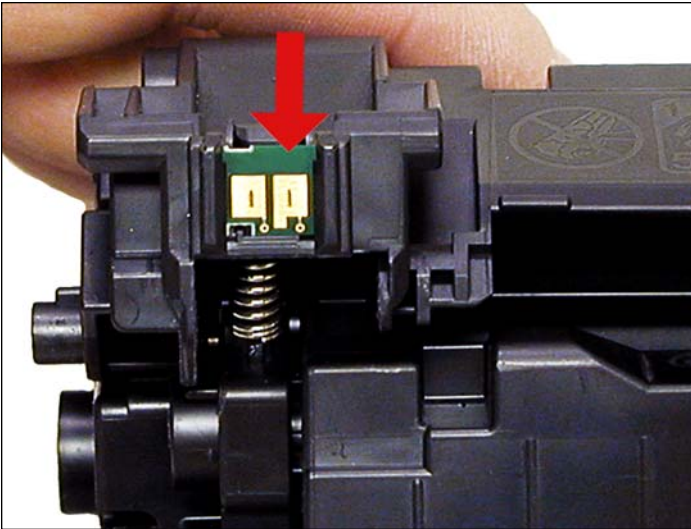

30. Replace the chip.

REPETITIVE DEFECT CHART

OPC Drum: 75mm
Magnetic roller: 31mm
PCR: 27mm

RUNNING TEST PAGES

Test pages must be run from the P1006 menu. Access the Printer Preferences menu, then Services, and Information pages. There are three test pages that can be selected. The Demo, Config, and Supply Status Page.

RUNNING THE CLEANING PAGE

The cleaning page for these machines can only be run from the Printer menu. HP recommends that for best results, a transparency be used. If a transparency is not available, use copier grade paper with a smooth surface.

To run this page, Access the printer preferences. Click on Device Settings. Press Start. The cleaning cycle takes up to 2 full minutes. The page will start and stop. Do not turn the printer off until the cleaning page has finished printing.

PRINTER TROUBLESHOOTING

As with all low cost machines these days, this series of these machines do not have a display panel. All the error codes consist of different pattern of the two lights. Information on the lights is very poor. Even the service manual is terrible.

TOP LIGHT BLINKING: Cartridge door open, no print cartridge installed, or there is a paper jam.

BOTH LIGHTS ON: Fatal error; turn the printer off, and unplug it for 30 minutes. If the error still exists, the printer has a major problem. There is no information yet on what these problems may be. (The service manual has not been released yet).

BOTH LIGHTS BLINKING: A printer initialization is in progress.